

# mouldings & specialty



WOODLAND

EST 1965





WOODLAND

EST 1965

# STARTING WITH A COMMITMENT TO EXCELLENCE.

---

Woodland combines state of the art production technology with old fashioned personal attention to quality and service.

**The best of nature in your home.**



# BASEBOARDS

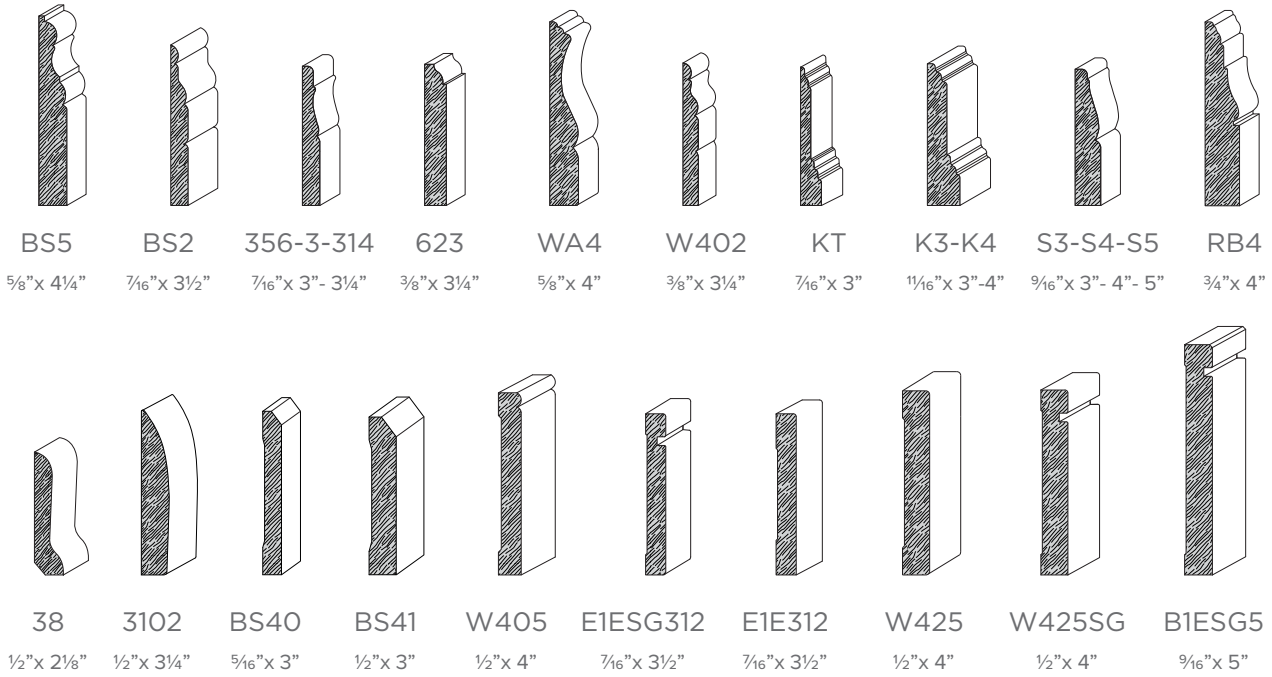

# CASINGS



3000  
7/16" x 1 1/2"



3002  
7/16" x 2 1/8"



3014SP  
5/8" x 2 1/2"



356-112  
7/16" x 1 1/2"

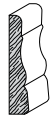

356-218  
7/16" x 2 1/8"

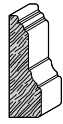

F  
1 1/16" x 2 3/16"

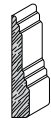

FT  
7/16" x 2 3/16"



CS2  
7/16" x 2 3/4"

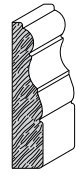

CS5  
1 1/16" x 3"

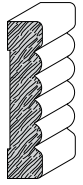

CS8  
3/4" x 3 1/4"



7290  
3/4" x 3 3/8"

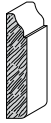

625  
3/8" x 2 1/4"



RB3  
3/4" x 3"



RT  
7/16" x 2 3/16"



R  
9/16" x 2 3/16"

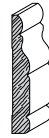

W401  
3/8" x 2 1/2"



WA  
3/4" x 2 5/8"



E2E212  
1/2" x 2 1/2"



W423  
5/8" x 3"

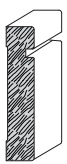

W423SG  
5/8" x 3"

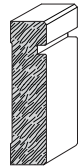

B2ESG3  
3/4" x 3"



W403  
5/8" x 3"



E2ESG212  
1/2" x 2 1/2"



CS40  
3/8" x 2 3/16"



CS41  
5/8" x 2 3/16"

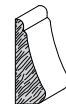

P  
9/16" x 1 1/16"

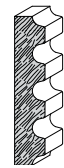

3600-01-02-03  
3/4" x 2 1/2" - 3 1/2" - 4 1/2" - 5 1/2"





## COVES

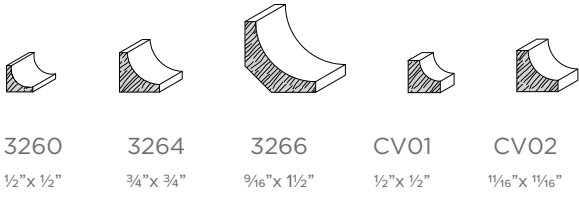

## CHAIR RAILS

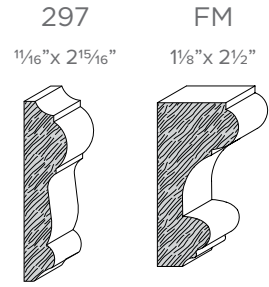

## ROUNDS

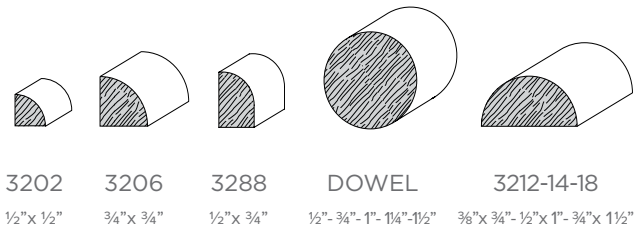

## BAR RAIL



## CORNICES

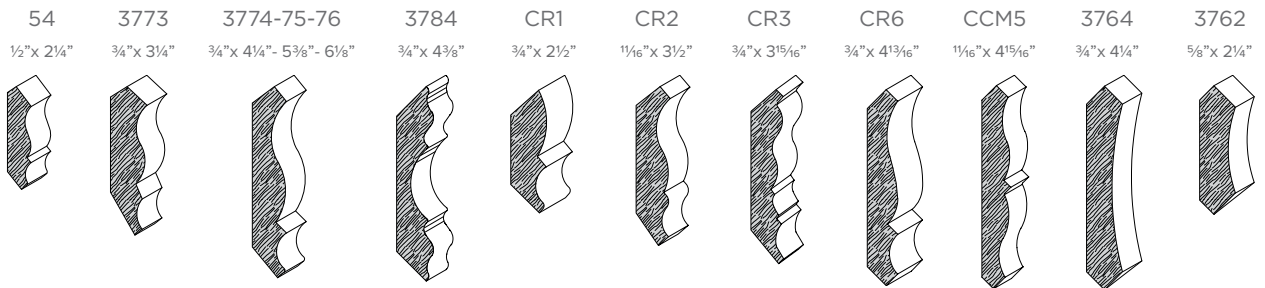

## CROWNS

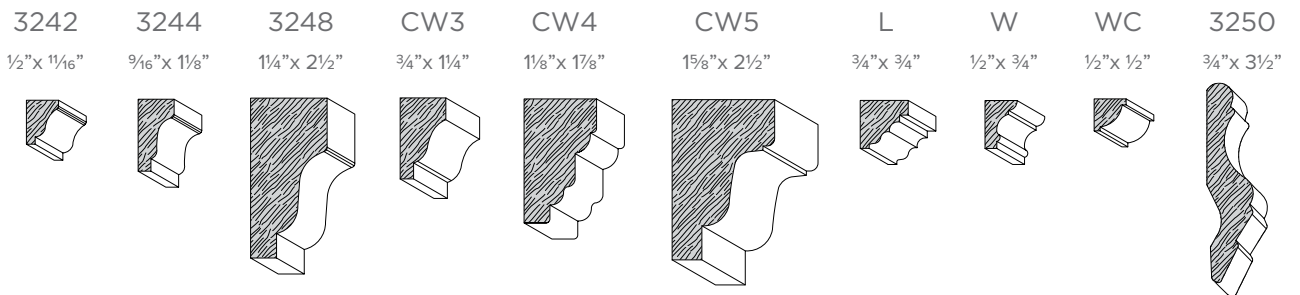

## TRANSITION MOULDINGS



4000, 4001	T4016	T4013	4005	T4017	T4014	T4011	T4018	T4019	SPLINE
1" x 3/4"	1 5/16" x 3"	3/4" x 2"	3/4" x 2 1/4"	3/4" x 2 1/4"	5/8" x 1 1/2"	5/8" x 1 3/8"	3/4" x 2"	3/4" x 2"	1/2" x 1/4"
FOR 3/4" + 5/16"	FOR 1/2"	FOR 1/4"	FOR 3/4" + 5/16"	FOR 1/2"	FOR 1/4"	FOR 1/4"	FOR 7/16" + 9/16"	FOR 9/16"	
FLOORING	FLOORING	FLOORING	FLOORING	FLOORING	FLOORING	FLOORING	FLOORING	FLOORING	

## ANGLE BEADS

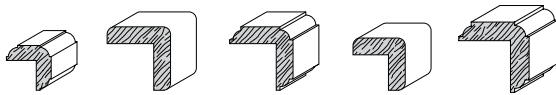

2163	3280	3281	3282	3283
3/4" x 3/4"	1 1/4" x 1 1/4"	1 1/4" x 1 1/4"	7/8" x 7/8"	1 3/8" x 1 3/8"
1/2" IM	3/4" IM	3/4" IM	9/16" IM	1 1/16" IM

IM = INSIDE MEASUREMENTS

## GLASS BEADS

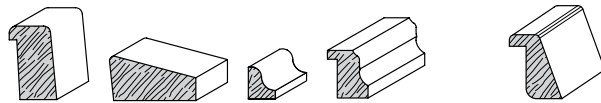

3285	3312	GB	GB51	GB52-12-34-58-916
7/16" x 1"	5/8" x 1 1/4"	3/8" x 1/2"	5/8" x 1 1/4"	3/8" x 5/8" - 7/8" - 3/4" - 1 1/16"
1 3/16" OS			9/16" OS	1/2" - 9/16" - 5/8" - 3/4" OS

OS = OFF SET

## DOOR STOPS AND ASTRIGALS

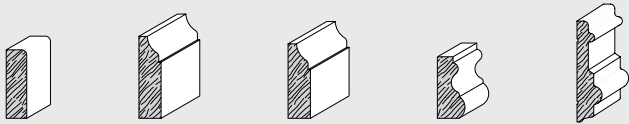

3422	936	936114	AS15	AS18
3/8" x 1 1/4"	3/8" x 1 3/8"	3/8" x 1 1/4"	1/2" x 1 1/8"	1/2" x 2"

## DOOR CAPS

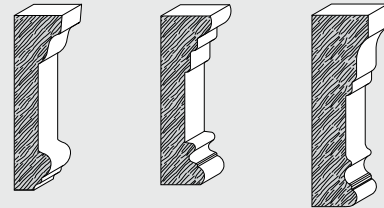

1300	1305	1310
1 1/16" x 3 7/8"	1 1/8" x 3 3/4"	1 1/4" x 4 1/4"

## WINE GLASS MOULDINGS

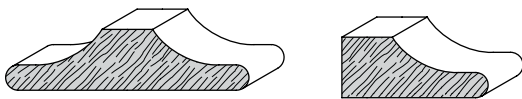

B15	B16
3/4" x 3"	3/4" x 1 3/4"

## DRAWER HANDLES



KCH134-1916	KCH
1 3/16" x 1 1/16" - 1 3/16" x 1 9/16"	7/8" x 2 1/8"



## CABINET MOULDINGS

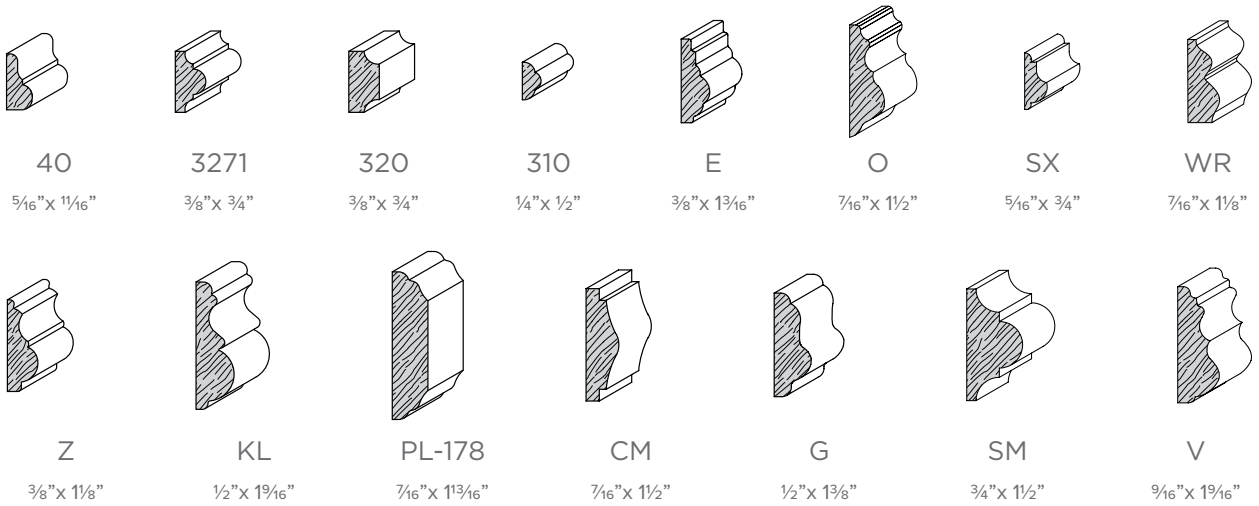

## PANEL MOULDINGS

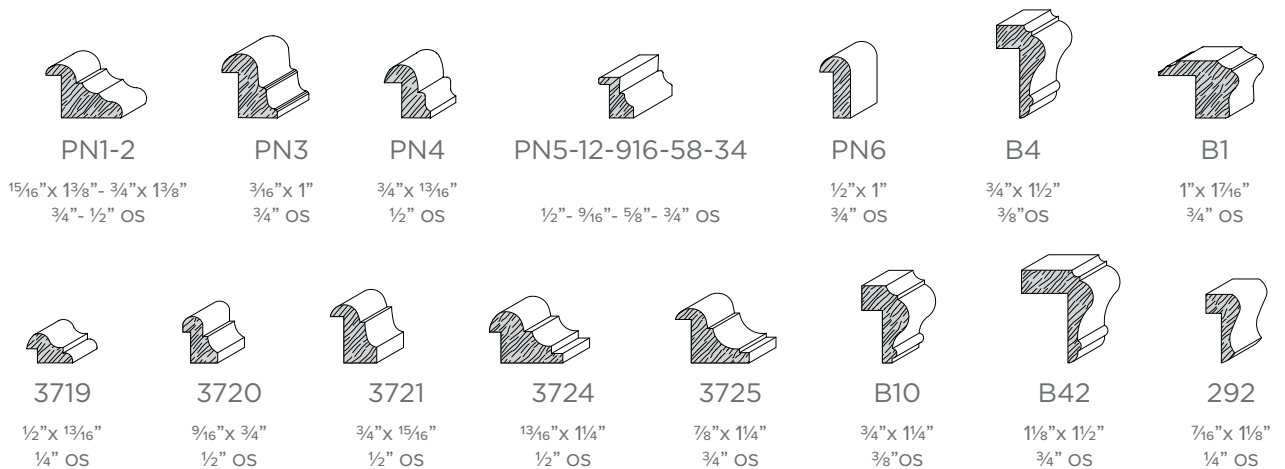

OS = OFF SET

## SCREEN MOULDINGS

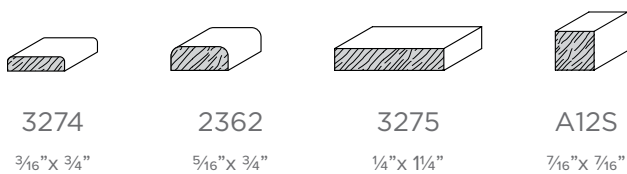

## BURLAP MOULDINGS

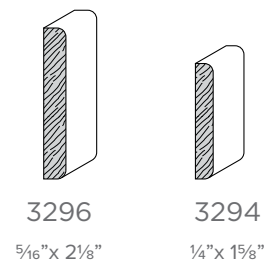

## CORNER CASING BLOCKS

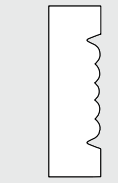

PROFILE



PROFILE  
BEVEL

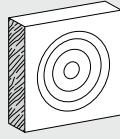

CCB212T  
 $\frac{3}{4}$ "x  $2\frac{1}{2}$ "

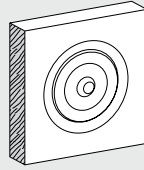

CCB3T  
 $\frac{3}{4}$ "x  $3$ "-  $1\frac{5}{16}$ "x  $3$ "

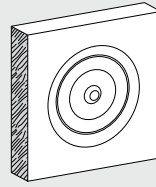

CCB312T  
 $\frac{3}{4}$ "x  $3\frac{1}{2}$ "-  $1\frac{5}{16}$ "x  $3\frac{1}{2}$ "

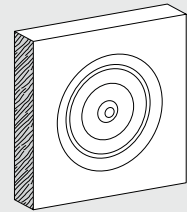

CCB4T  
 $\frac{3}{4}$ "x  $4$ "



PROFILE



PROFILE  
BEVEL

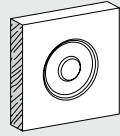

CCB212  
 $\frac{3}{4}$ "x  $2\frac{1}{2}$ "

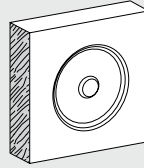

CCB3  
 $\frac{3}{4}$ "x  $3$ "

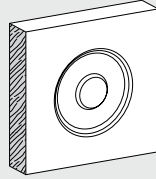

CCB312  
 $\frac{3}{4}$ "x  $3\frac{1}{2}$ "

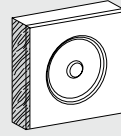

CCB212BEV  
 $\frac{3}{4}$ "x  $2\frac{1}{2}$ "-  $\frac{5}{8}$ "x  $2\frac{1}{2}$ "

## CORNER BASE BLOCKS

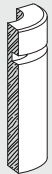

CBBEIESG312  
 $\frac{7}{16}$ "x  $3\frac{1}{2}$ "



CBBEIE312  
 $\frac{7}{16}$ "x  $3\frac{1}{2}$ "

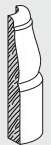

CBBS3  
 $\frac{9}{16}$ "x  $3$ "



CBBWA  
 $\frac{3}{4}$ "x  $2\frac{3}{8}$ "



CBBWA4  
 $\frac{9}{16}$ "x  $4$ "



CBB093-94-95  
15mm x  $3\frac{1}{4}$ "-  $4$ "-  $5$ "



CBB3140  
9mm x  $3\frac{1}{4}$ "

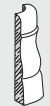

CBB356218  
 $\frac{7}{16}$ "x  $2\frac{1}{8}$ "

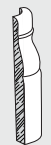

CBB3563  
 $\frac{7}{16}$ "x  $3$ "



CBB356314  
 $\frac{7}{16}$ "x  $3\frac{1}{4}$ "

## ROUND CASING BLOCKS

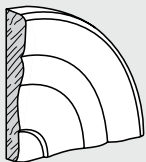

RCB356-FL  
 $\frac{1}{2}$ "x  $2\frac{3}{8}$ "-  $\frac{7}{16}$ "x  $2\frac{1}{8}$ "

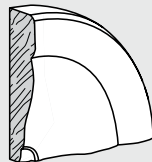

RCBR  
 $\frac{9}{16}$ "x  $2\frac{3}{16}$ "

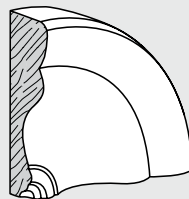

RCBWA  
 $\frac{3}{4}$ "x  $2\frac{5}{8}$ "

## PLINTH BLOCKS

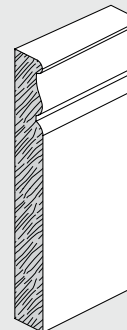

PB151-34  
 $1\frac{5}{16}$ "x  $3\frac{1}{2}$ "x  $6$ "  
 $1\frac{5}{16}$ "x  $2\frac{1}{2}$ "x  $6$ "  
 $1\frac{5}{16}$ "x  $3$ "x  $6$ "  
 $1\frac{5}{16}$ "x  $4$ "x  $6$ "  
 $\frac{3}{4}$ "x  $2\frac{1}{2}$ "x  $6$ "  
 $\frac{3}{4}$ "x  $3$ "x  $6$ "  
 $\frac{3}{4}$ "x  $3\frac{1}{2}$ "x  $6$ "  
 $\frac{3}{4}$ "x  $4$ "x  $6$ "

## COLD AIR REGISTERS

---

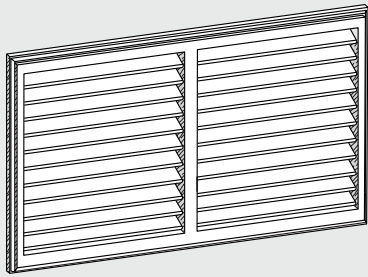

CAR1016-1024-1032  
10"x 16"- 10"x 24"- 10"x 32"

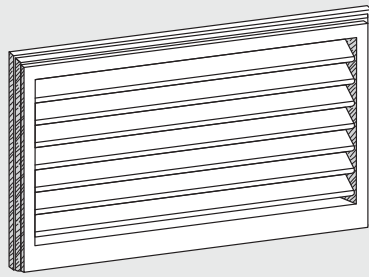

CAR16-24-32  
8"x 16"- 8"x 24"- 8"x 32"

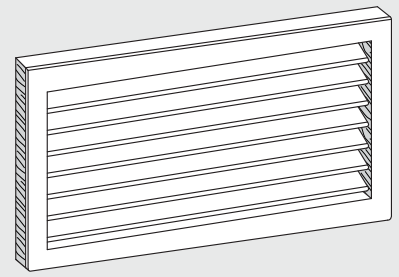

CARE1016-1024-16-24-32  
10"x 16"- 10"x 24"- 8"x 16"- 8"x 24"- 8"x 32"

## HOT AIR REGISTERS

---

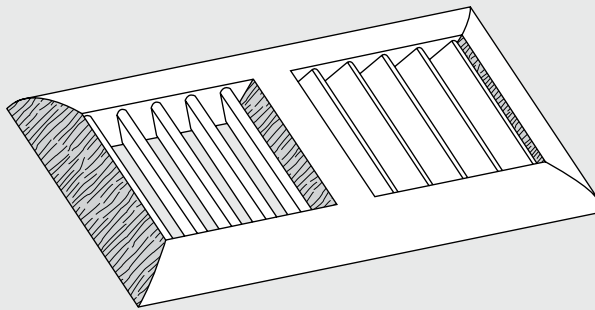

SURFACE MOUNT  
2½"x 12"- 3"x 10"- 4"x 10"- 4"x 12"

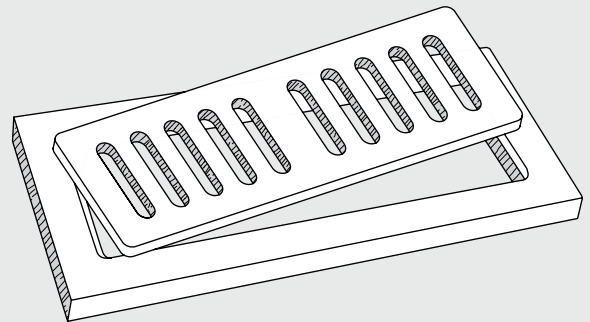

FLUSH MOUNT  
2½"x 12"- 3"x 10"- 4"x 10"- 4"x 12"





# SHIPLAP

---

Rough Sawn Knotty Pine Shiplap adds a beautiful rustic accent to a wide range of projects. Whether you are into country or rustic industrial, this product can deliver the character you are looking for.

Available in 1x6 and 1x8 raw unfinished or finished in a classic barn board grey.

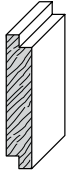

1x6 RSK

$\frac{3}{4}$ "x  $5\frac{1}{2}$ "  
5"FACE

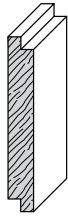

1x8 RSK

$\frac{3}{4}$ "x  $7\frac{1}{4}$ "  
 $6\frac{1}{16}$ "FACE































# BOARD PROGRAM

---

Woodland's Smooth 4 Side Board Program is Premium Quality. The boards are hand selected from the best grades of hardwood lumber available.

When colour, consistency and premium quality is your standard, Woodland is the source.

S4S is also available in other species.

SIZE	ACTUAL SIZE	OAK	MAPLE	ASPEN
1x2	3/4"x 1 1/2"			
1x3	3/4"x 2 1/2"			
1x4	3/4"x 3 1/2"			
1x5	3/4"x 4 5/8"			
1x6	3/4"x 5 1/2"			
1x8	3/4"x 7 1/4"			
1x10	3/4"x 9 1/4"			
1x12	3/4"x 11 1/4"			
2x2	1 1/2"x 1 1/2"			
2x4	1 1/2"x 3 1/2"			
2x6	1 1/2"x 5 1/2"			

## WOOD SPECIES

---

Woodland specializes in manufacturing mouldings and millwork in many profiles and in many species. Although many dealers only stock a small number of species, Woodland has the capability to produce mouldings in any of those specified below. Contact your local dealer for available profiles and species or a quote on your specific requirements.

Some species may require longer lead times or have specific limitations.



Red Oak



Maple



Aspen



Poplar



Knotty Pine



Clear Pine



Alder



Knotty Alder



White Oak



Mahogany



Beech



Walnut



Hickory



Cedar



Fir

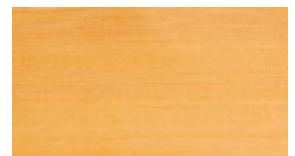

VG Fir



Cherry



WOODLAND SUPPLY & MFG. LTD.  
867 McLeod Avenue - Winnipeg, Manitoba R2G 0Y4  
Phone: 1 (204) 668-0079 | Toll Free: 1 (888) 665-0343  
[woodlandsupply.ca](http://woodlandsupply.ca)



Distributed in Canada By:

